

CLADDING FIELD SURVEY

CAB - ONE SPEED SIDE OPENING - RIGHT HAND RETURN



info@fabacab.com
800.800.4960

1600 Main Street
Anderson, IN 46016

JOB NAME: _____

SURVEYOR NAME: _____

SURVEYOR PHONE NUMBER: _____

CAPACITY: _____ lbs.

ELEVATOR NUMBER: _____

Survey Tips:

- 1) Send pictures.
- 2) No "rolling tape" measurements.
 - a. Make mark and measure to it.
- 3) Look for tapers in walls/jambs/strikes/returns.
- 4) Send C.O.P. dimensions.
- 5) Measure strike/return heights from threshold or smallest measurement, including cab floor.

1. Transom: (Complete section entirely and enter all dimensions in inches, not feet)

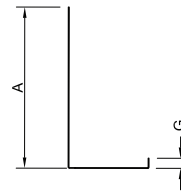
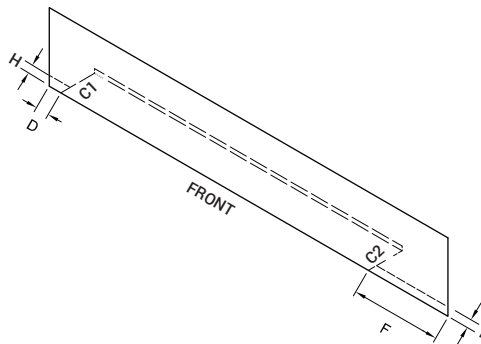
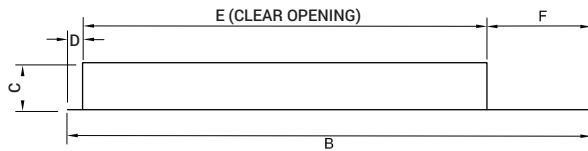
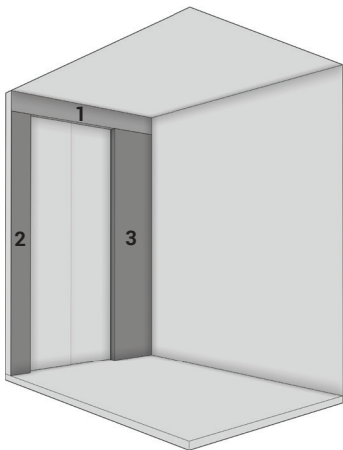

A: _____"
B: _____"
C1: _____"
C2: _____"
D: _____"
E: _____"
F: _____"
G: _____"
H: _____"
I: _____"

*As an industry standard, surveys are conducted from within the car looking out.

2. Strike: (Complete section entirely and enter all dimensions in inches, not feet)

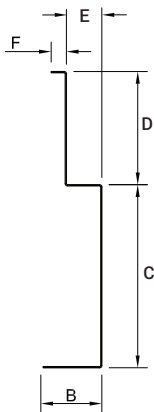
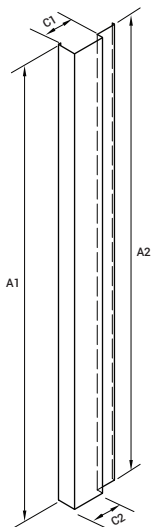

A1: _____"
A2: _____"
B: _____"
C1: _____"
C2: _____"
D: _____"
E: _____"
F: _____"

3. Return: (Complete section entirely and enter all dimensions in inches, not feet)

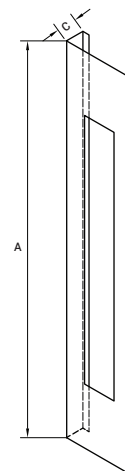
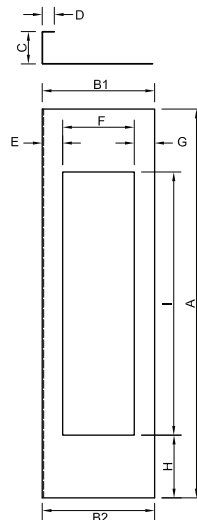

A: _____"
B1: _____"
B2: _____"
C: _____"
D: _____"
E: _____"
F: _____"
G: _____"
H: _____"
I: _____"

FABRICATION APPROVAL SIGNATURE: _____

(A signature serves as the final approval of the above dimensions)