

HORIZONTAL PANEL SYSTEM

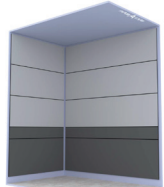

COOPERSTOWN

CYPRESS

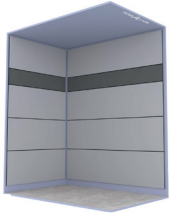
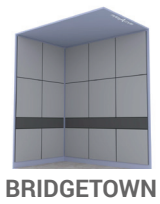
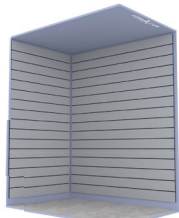

HAVANA

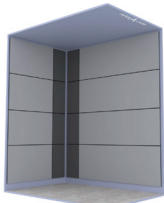

LA VEGA

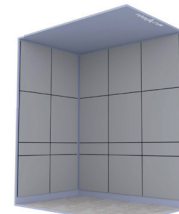

SANTA CRUZ



SANTIAGO

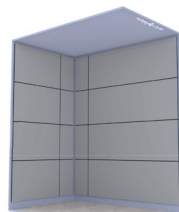

SANTO DOMINGO

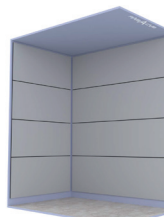

WILLEMSTAD



FABACVB

INSTALLATION INSTRUCTIONS:
HORIZONTAL PANEL SYSTEM

4 STEP PROCESS:

1. General Guidelines
2. Reveal Installation
3. Panel Installation
4. Rail Installation

NEED MORE HELP?

WATCH A VIDEO TUTORIAL:

1. Open the Camera app.
2. Scan Q.R. Code.
3. Select the link.



24 HOUR TECHNICAL HOTLINE: 800.800.4960

Our staff is always ready to answer any questions, night or day.

SPECIAL NOTES:

1 HORIZONTAL PANEL SYSTEM GENERAL GUIDELINES

TIP: Always inspect the product for shipping damage before demolition of the existing cab interior. If any damage is found, please take photos and contact our 24 hour technical hotline detailing the extent of the damage.



1.1 Review 'customer drawings' and 'packing list'.

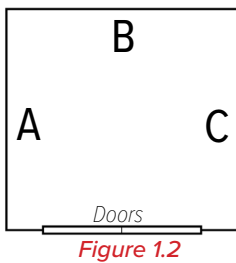

1.2 Elevation A,B & C represent walls as viewed from inside the cab looking out as shown in Figure 1.2.

1.3 Demo existing cab interior components including wall panels, hand rails, reveals, and mounting brackets.

Figure 1.2

1.4 If you are replacing the ceiling please follow the ceiling installation instructions provided in a separate document in your hardware kit as shown in Figure 1.4. This should be completed prior to installing the wall panel system.

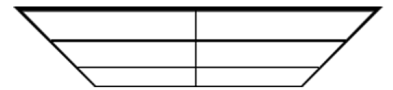

Install Ceiling First
Figure 1.4

TIP: Ensure you have all the required tools before installing.
Please follow Personal Protective Gear requirements for your region.



2 HORIZONTAL PANEL SYSTEM REVEAL INSTALLATION

2.1 Install Base Reveals.

TIP: If you have ordered **Black Finish** reveals, ensure to hide the holes on the reveals behind the panels. (These holes are used for powder coating purposes.)

Our standard base reveal is 5" tall and ½" shorter than the width of each cab wall.

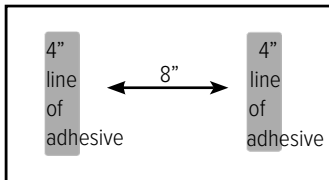

Figure 2.1.1

2.1.1 Apply adhesive on base reveal as shown in

Figure 2.1.1.

2.1.2 Center the reveal against the wall along the floor and apply light pressure to distribute the adhesive evenly as shown in Figure 2.1.2.

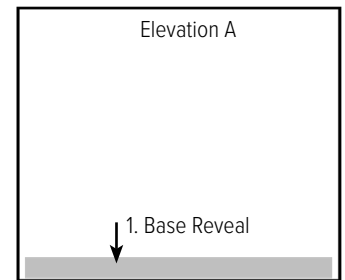

Figure 2.1.2

2.1.3 Repeat steps 2.1.1 through 2.1.2 for Elevation "B" and "C", as applicable.

2.2. Install Front Vertical Reveals.

TIP: Our standard front vertical reveal is 2" wide and has a length that will reach from the floor of the cab to the top of the highest wall panel.

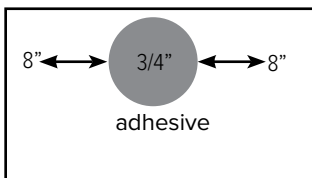

Figure 2.2.1

2.2.1 Apply adhesive on front vertical reveals as shown in Figure 2.2.1.

2.2.2 Place the front vertical reveal on the floor, against the wall & over existing base & apply light pressure to the length of it as shown in Figure 2.2.2.

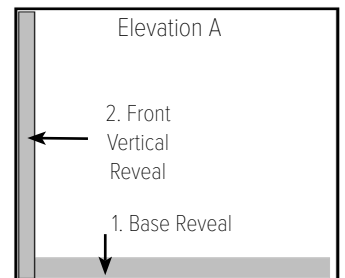

Figure 2.2.2

2.2.3 Repeat steps 2.2.1 through 2.2.2 for Elevation "B" & "C", as applicable.

2.3 Install Corner Reveals.

TIP: Our standard corner reveal is 2" wide in both directions from the corner and has a length that will reach from the floor of the cab to the top of the highest wall panel.

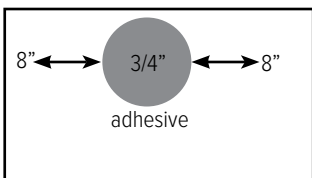

Figure 2.3.1

2.3.1 Apply adhesive on corner reveals as shown in Figure 2.3.1.

2.3.2 Place the corner reveal on the floor, against the wall & over existing base & apply light pressure to the length of it as shown in

Figure 2.3.2.

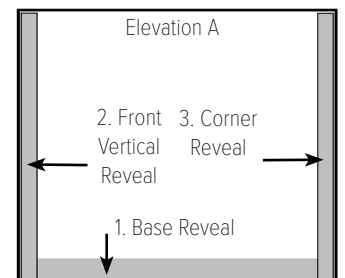

Figure 2.3.2

2.3.3 Repeat steps 2.3.1 through 2.3.2 for Elevation "B" and "C", as applicable.

TIP: Be sure to drill ventilation holes as required by your jurisdiction.

3 HORIZONTAL PANEL SYSTEM

PANEL INSTALLATION 1/2

3.1 Install the Aluminum J-Channel.

TIP: It is extremely important that the J-channel is level on each wall and level from wall to wall.

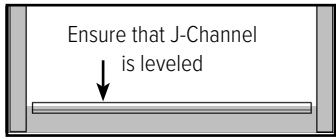

Figure 3.1.1

3.1.1 Set the J-channel on the base reveal, center it on the wall and level it as shown in Figure 3.1.1.

3.1.2 The J-Channel overlaps the base reveal by 1" as shown in Figure 3.1.2.

3.1.3 If the J-channel is level, fasten it to the cab shell using the #10 x 3/4 inch self-tapping screws provided in the hardware kit.

3.1.4 If the J-channel is not level, find the high end of the J-channel and fasten it to the cab wall using a self-tapping screw mentioned above.

3.1.5 Bring the low end of the J-channel to level and fasten to the cab shell.

3.1.6 Repeat steps 3.1.1 through 3.1.5 for Elevation "B" & "C".

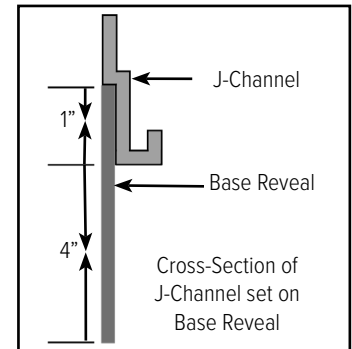

Figure 3.1.2

3.2 Install Bottom Panels.

TIP: We recommend installing the bottom panel on all walls before any of the upper panels. This is to ensure all panels are level with the adjacent panels on all walls.

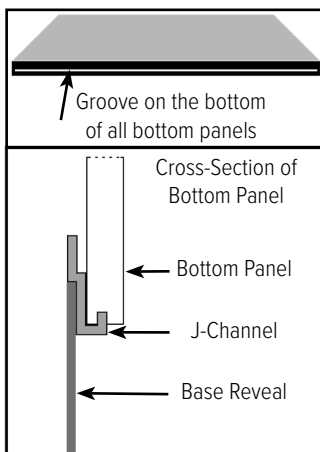

Figure 3.2.1

3.2.1 Set bottom panel groove on the J-Channel as shown in Figure 3.2.1.

3.2.2 Fasten the top of the panel to the cab shell with the provided screws.

3.2.3 Repeat steps 3.2.1 through 3.2.2 for Elevation "B" & "C" as shown in Figure 3.2.3. Ensure all the bottom panels are levelled.

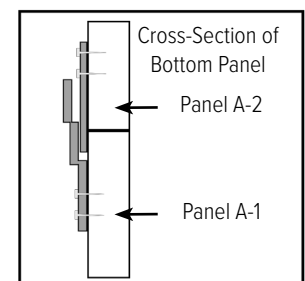

Figure 3.2.4

3 HORIZONTAL PANEL SYSTEM

PANEL INSTALLATION 2/2

3.3 Install Middle Panels.

TIP: Be sure the upper panel sits flush with the lower panel as shown in **Figure 3.3**.

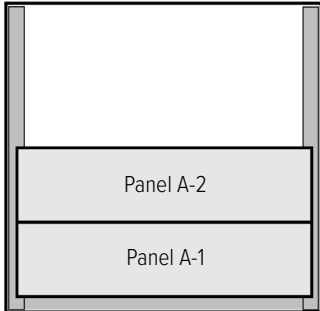

Figure 3.3.1

3.3.1 Place Panel “A-2” on top of Panel “A-1” as shown in **Figure 3.3.1**.

3.3.2 Fasten the top of the panel to the cab wall with the provided screws. Repeat step for “A-3”.

3.3.3 Repeat steps 3.3.1 through 3.3.2 for Elevation “B” & “C” for the rest of the panels. Ensure all panels on the side are levelled.

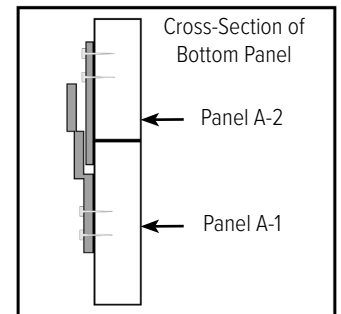

Figure 3.3

3.4 Install Top Panels.

TIP: If your system utilizes an island ceiling or an existing ceiling, you will not have access to the top panel mounting screws as the standard perimeter gap around the ceiling is 2”. In this case, the top panels will have pre-installed Z-clips along the top of each panel.

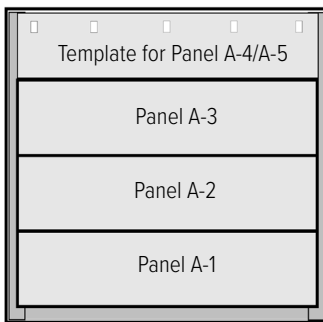

Figure 3.4.1

3.4.1 Place template marked “Elevation A/C Template” on top of the installed wall panel and screw it to the wall as shown in **Figure 3.4.1**.

3.4.2 Be sure to line up the vertical edges with the lower panel for proper alignment.

3.4.3 Fasten Z-clips to the cab wall at each open slot in the template as shown in **Figure 3.4.3**.

3.4.4 Be sure that the Z-clip does not rotate when you tighten the mounting screws as this will result in mis-alignment with the mating Z-clip.

3.4.5 Repeat steps 3.4.1 through 3.4.4 for “Elevation C”, if applicable.

3.4.6 Repeat steps 3.4.1 through 3.4.4 for Elevation “B”, with the provided template marked as “Elevation B Template”, if applicable.

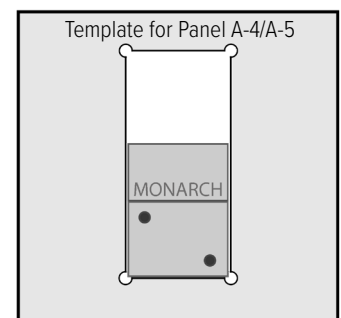

Figure 3.4.3

TIP: Apply a small dab of adhesive on a couple of Z-Clips to avoid vibrations.

3.4.7 Locate the wall panels for each wall to install them. Install the top panel by lifting the panel above the Z-Clips and sliding the panel down to interlock the Z-Clips.

4 HORIZONTAL PANEL SYSTEM

RAIL INSTALLATION

4.1 Install the Hand Rail.

TIP: If your panel system was ordered with hand rails, the wall panels will have pre-drilled holes at each stand off location. The holes are 7/16" in diameter.

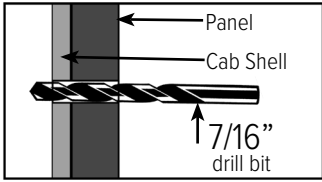

Figure 4.1.1

4.1.1 Drill a 7/16" hole in the cab shell at each panel hole location as shown in Figure 4.1.1.

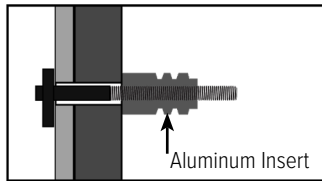

Figure 4.1.2

4.1.2 Insert a 3/8" T-bolt through the hole and push the stud in until the toggle drops outside of the elevator cab shell as shown in Figure 4.1.2. Apply a few drops of Loctite to the threads.

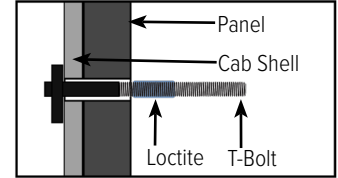

Figure 4.1.3

4.1.3 Thread the 3/4" aluminum insert onto the T-bolt as shown in Figure 4.1.3.

4.1.4 Tighten the aluminum insert using a 5/8" wrench on the flats of aluminum insert.

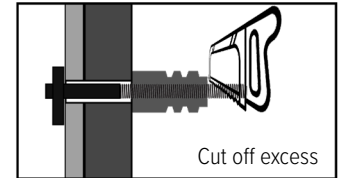

Figure 4.1.5

4.1.5 Cut the excess 3/8" stud off with a hacksaw as shown in Figure 4.1.5.

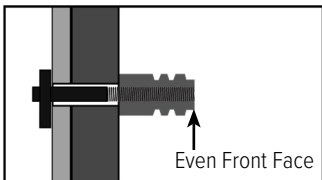

Figure 4.1.6

4.1.6 Make sure the front face of the aluminum insert is flush with the T-Bolt as shown in Figure 4.1.6.

4.1.7 Repeat steps 4.1.1 through 4.1.6 for all remaining mounting holes.

TIP: The two allen set screw holes located on each hand rail stand off should be facing down and not be visible from the top.

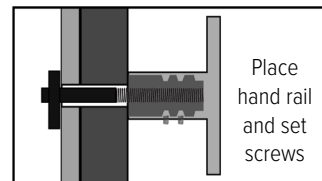

Figure 4.1.8

4.1.8 Locate the correct hand rail for wall "A" and slide the hand rail stand offs over the aluminum inserts until the stand offs are tight against the wall panel as shown in Figure 4.1.8.

4.1.9 Insert two allen set screws into each stand off and tighten using a 5/64" allen wrench as shown in Figure 4.1.9.

4.1.10 Make sure the hand rail is pushed tight against the panel before tightening set screws. Allen set screws will recess completely if hand rail is completely installed.

4.1.11 Repeat steps 4.1.8 through 4.1.10 for the remaining hand rails.

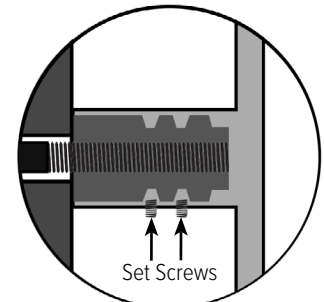

Figure 4.1.9

4.2 Install the Bumper Rail.

4.2.1 For bumper rail installation, repeat steps 4.1.1 through 4.1.10.

